



PASSION FOR PARTS



LOADING RAMPS
RAMPE DI CARICO
LADERAMPEN

INDICE

INDEX

INHALT

2	COME DETERMINARE IL CODICE DELLA RAMPA HOW TO DEFINE THE PART NUMBER BESTIMMUNG DES RAMPENCODES
3	COME ORDINARE LE RAMPE DI CARICO HOW TO PLACE AN ORDER BESTELLEN DER LADERAMPEN
4	LA MASSIMA QUALITÀ DEL MADE IN ITALY THE BEST <i>MADE IN ITALY</i> QUALITY MAXIMALE QUALITÄT <i>MADE IN ITALY</i>
6	MONTANTE 72 mm SUPPORT 72 mm HALTERUNG 72 mm
7	MONTANTE 95 mm SUPPORT 95 mm HALTERUNG 95 mm
8	MONTANTE 112 mm SUPPORT 112 mm HALTERUNG 112 mm
10	MONTANTE 127 mm SUPPORT 127 mm HALTERUNG 127 mm
12	MONTANTE 140 mm SUPPORT 140 mm HALTERUNG 140 mm
14	MONTANTE 155 mm SUPPORT 155 mm HALTERUNG 155 mm
16	MONTANTE 170 mm SUPPORT 170 mm HALTERUNG 170 mm
18	MONTANTE 190 mm SUPPORT 190 mm HALTERUNG 190 mm
19	MONTANTE 220 mm SUPPORT 220 mm HALTERUNG 220 mm
21	DIAGRAMMA CHART DIAGRAMM

COME DETERMINARE IL CODICE DELLA RAMPA

HOW TO DEFINE THE PART NUMBER

BESTIMMUNG DES RAMPENCODES



ITR® RAMPE ITR® LOADING RAMPS ITR®-RAMPEN	MONTANTE SUPPORT HALTERUNG	LUNGHEZZA LENGTH LÄNGE	LARGEZZA WIDTH BREITE	CON o SENZA BORDO WITH or WITHOUT CURBS MIT oder OHNE RAND	CON o SENZA GOMMA WITH or WITHOUT RUBBER MIT oder OHNE GUMMIBELAG
FISSO / FIXED / FEST	07	15	L	1	1
	09	20	S	0	0
	11	25			
	12	30			
	14	32			
	15	35			
	17	40			
	19	45			
	22	50			

SIGNIFICATO DEI NOSTRI CODICI

OUR PART NUMBERS

BEDEUTUNG UNSERER CODES

UEL	XX	XX	L	X	X
Codice fisso Indica il codice ITR delle rampe	Altezza del montante (S) 07 = 72 mm	Lunghezza della rampa 15 = 1500 mm	L = versione larga S = versione stretta	1 = con bordo 0 = senza bordo	1 = con gomma 0 = senza gomma
Fixed code Indicates the code for ITR ramps	The support height (S) 07 = 72 mm	Length of the ramp 15 = 1500 mm	L = wide version S = narrow version	1 = with curb 0 = without curb	1 = with rubber 0 = without rubber
Fester Code Gibt die Höhe der Halterung an	Gibt die Höhe der Halterung an (S) 07 = 72 mm	Gibt die Länge der Rampe an 15 = 1500 mm	L = breite Version S = schmale Version	1 = mit Rand 0 = ohne Rand	1 = mit Gummibelag 0 = ohne Gummibelag

ESEMPIO

EXAMPLE

BEISPIEL

UEL	17	35	L	0	1
↓	↓	↓	↓	↓	↓
FISSO Fixed Fest	MONTANTE Support Halterung	LUNGHEZZA length Länge	VERSIONE LARGA Wide version Breite Version	SENZA BORDO without curb Ohne Rand	CON GOMMA with rubber Mit Gummibelag

⇒ Codice UEL1735L01 significa rampa con montante 170 mm, lunghezza di 3500 mm, nella versione larga, senza bordo, con gomma.
 Part number UEL1735L01 means ramp with support of 170 mm, length of 3500 mm, wide version, without curb, with rubber.
 Der Code UEL1735L01 gibt an: Rampe mit Halterung 170 mm, 3500 mm, breite Version, ohne Rand, mit Gummibelag.

COME ORDINARE LE RAMPE DI CARICO

HOW TO PLACE AN ORDER
BESTELLEN DER LADERAMPEN

IMPORTANTE
IMPORTANT
WICHTIG 

Al fine di poter offrire a tutti gli operatori di settore un buon servizio, vi preghiamo di voler tener conto dei suggerimenti di seguito riportati. Nel caso non troviate nel nostro range di prodotto, la risposta alle vostre esigenze, vi preghiamo di contattarci, vi proporremo la migliore soluzione su misura per voi.

In order to offer the best service, we would like to suggest our clients how to identify the correct loading ramp thanks to the notes listed here below. If you cannot identify the product you need within our product range do not hesitate to contact us.

Um allen Betreibern der Branche eine guten Service bieten zu können, bitten wir Sie, folgende Ratschläge zu berücksichtigen. Sollten Sie in unserem Sortiment kein Produkt finden, das Ihren Anforderungen entspricht, bitten wir Sie, sich mit uns in Verbindung zu setzen. Wir werden Ihnen die beste maßgeschneiderte Lösung für Sie anbieten.

- 1** Specificare IL PESO della macchina (Es.: 35 Q.li);
Mention the WEIGHT of the machine (E.g.: 3,5 Tons.);
Geben Sie DAS GEWICHT des Fahrzeugs an (z.B.: 3,5 Tonnen);



- 2** Specificare il PASSO della macchina. Come determinare il passo?
Mention the AXLE DISTANCE of the machine, How to determine the axle distance (pitch) of the machine?
Geben Sie den RADSTAND des Fahrzeugs an. Wie bestimmt man den Radstand?



P = Passo / Axle distance / Radstand



NOTA BENE: ad ogni passo "P" corrisponderà una portata, che sarà poi specificata nelle pagine successive per ogni tipo di rampa e per ogni valore del passo, per convenzione il passo sarà indicato in 3 categorie dimensionali diverse.

Fanno eccezione le macchine con ruote di piccole dimensioni a bassa distanza dal suolo come i carrelli elevatori. Per questa tipologia di veicoli l'informazione del passo non concorre alla definizione di tipologia di rampa. In questi casi per identificare il tipo di rampa, vi preghiamo di contattarci.

WARNING: each axle distance "P" corresponds to a load capacity; this value will be specified in the brochure for each type of loading ramp and for each axle distance value. This last will be shown in 3 different dimensional ranges.

Vehicles with small ground distance, like forklift or other machines with small wheels represent an exception. In these specific cases the axle distance is not relevant in order to define the type of ramp. In these cases to identify the correct loading ramp, please contact us.

HINWEIS:  Radstand „P“ entspricht eine Tragfähigkeit, die dann auf den folgenden Seiten für jeden Rampentyp und für jeden Radstand angegeben wird. Konventionell wird der Radstand in 3 unterschiedlichen Kategorien angegeben. Ausnahmen sind Fahrzeuge mit kleinen Rädern und geringem Bodenabstand, wie z.B. Gabelstapler. Für diesen Fahrzeugtyp ist die Angabe des Radstands zur Festlegung des Rampentyps nicht erforderlich. Bitte wenden Sie sich direkt an uns, um in solchen Fällen den Rampentyp zu bestimmen.

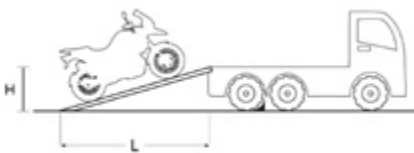

I codici delle rampe fanno riferimento alla rampa singola. Quindi, ad esempio, per la coppia di rampe UELO720S10 (x 2 pezzi) a passo 1000 mm, la portata massima è di 1630 kg. Nel caso, invece, di utilizzo della sola rampa singola UELO720S10 la portata massima sarà 815 kg.

The part numbers refer to the single ramp. Considering the ramp pair UELO720S10 (x 2 pcs) - axle distance 1000 mm - the max load capacity is 1630 kg. Otherwise in case of use of a single ramp the part number UELO720S10 and the max load sustained is 815 kg.

Die Rampen  beziehen sich auf die einzelnen Rampenelemente.  trägt beispielsweise für das Rampenpaar UELO720S10 (x 2 Stück) mit Radstand 1000 mm die maximale Tragfähigkeit 1630 kg. Wenn hingegen nur eine einzige Rampe vom Typ UELO720S10 verwendet wird, beträgt die maximale Tragfähigkeit 815 kg.

- 3** Specificare se il mezzo è GOMMATO oppure CINGOLATO
Mention if the machine is a WHEELED or a CRAWLED VEHICLE
Geben Sie an, ob es sich um ein BEREIFTES Fahrzeug oder ein RAUPENFAHRZEUG handelt



- 4** Specificare la LUNGHEZZA DELLA RAMPA NECESSARIA al fine di poter caricare/scaricare correttamente il mezzo sul/dal pianale; Qualora non fosse possibile indicare la lunghezza, si potrà ricavare considerando un'inclinazione massima del 30%

If the machine is CRAWLED mention the WIDTH OF THE CHAINS since this data may change the ramps specifications. Otherwise, it can be obtained considering a maximum inclination of 30%.

Geben Sie die BENÖTIGTE LÄNGE DER RAMPE an, um das Fahrzeug ordnungsgemäß auf dem Boden abzusetzen oder vorzunehmen; Falls die Länge nicht genau angegeben werden kann, kann sie unter Berücksichtigung einer maximalen Neigung von 30 % berechnet werden.

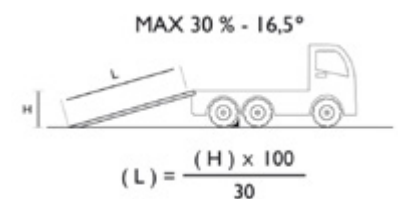

LA MASSIMA QUALITÀ DEL **MADE IN ITALY**

THE BEST **MADE IN ITALY** QUALITY

MAXIMALE QUALITÄT **MADE IN ITALY**

La produzione di rampe ITR segue le rigide procedure qualitative interne, definite in accordo con la certificazione ISO 9001. Tali procedure implicano l'adozione di alti standard di sicurezza nella progettazione tecnica, la quale contempla calcoli strutturali e analisi agli elementi finiti ed un'attenta valutazione dei rischi.

ITR loading ramps production follows company strict quality procedures elaborated in accordance to ISO 9001. Mentioned procedures imply the use of high safety standards at engineering stage including "structure calculations" and "finite element analysis".

Die Herstellung von ITR-Rampen erfolgt nach strengen internen Qualitätskriterien, die gemäß der Zertifizierung nach ISO 9001 bestimmt werden. Diese Verfahren setzen die Umsetzung hoher Sicherheitsstandards in der technischen Konstruktion voraus, die statische Berechnungen und Analysen der Endprodukte sowie eine sorgfältige Risikobewertung umfassen.

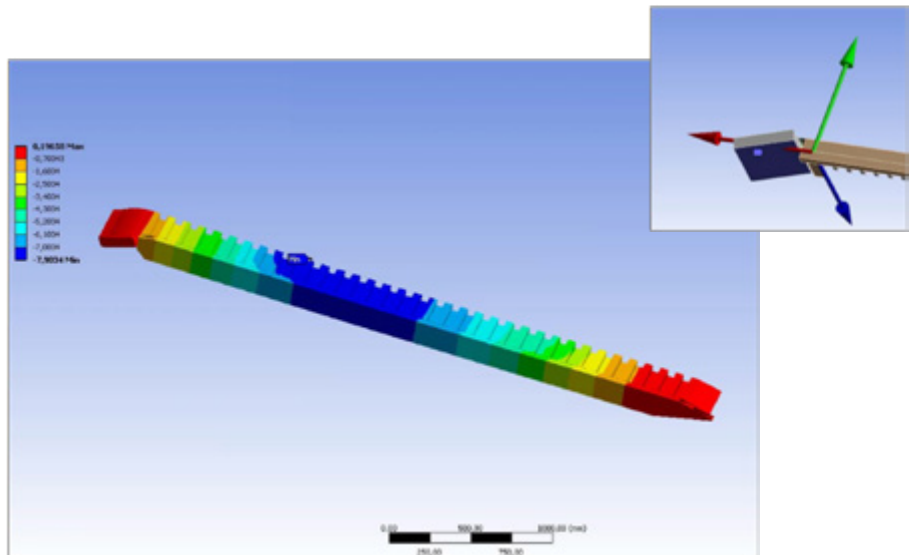

Le rampe movimentate manualmente, come quelle qui in oggetto, non sono coperte dalla direttiva macchine (Direttiva 2006/42/CE del 17 Maggio 2006, recepita in Italia con il decreto D.Lgs 17/2010 del 27 gennaio 2010) e quindi non devono essere dotate di marcatura CE e di dichiarazione di conformità. L'utilizzo di marcatura CE, quando non richiesto dalla normativa vigente, può essere oggetto di sanzione degli organismi preposti, in quanto si configura come uso improprio.

ITR Loading ramps are manually handled therefore they are not included in the Machinery Directive (Directive 2006/42/CE dated May 17th 2006 acknowledged by European countries in different dates and effective from early 2010). In this sense the loading ramps cannot bear the label CE and have the conformity certificate. The improper use of the CE label can be subject to penalty following to different European members' regulations.

Von Hand bewegte Rampen, wie die hier erwähnten, fallen nicht unter die Maschinenrichtlinie (Richtlinie 2006/42/EG vom 17. Mai 2006, umgesetzt in Italien mit der Gesetzesverordnung 17/2010 vom 27. Januar 2010) und müssen daher nicht mit einer CE-Kennzeichnung und einer Konformitätserklärung versehen sein. Die Verwendung der CE-Kennzeichnung kann, wenn dies nach geltendem Recht nicht vorgeschrieben ist, Gegenstand von Sanktionen seitens der dafür zuständigen Stellen sein, weil sie als missbräuchliche Verwendung eingestuft wird.

72mm

MONTANTE (S) / SUPPORT (S) / HALTERUNG (S)

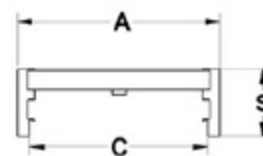
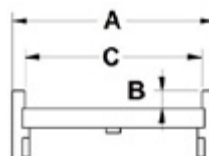
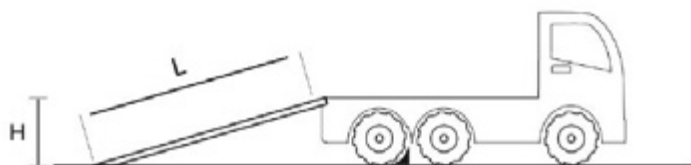

Tipo / Type / Typ
10 - 11

Tipo / Type / Typ
00 - 01

MONTANTE (S) 72 mm / SUPPORT (S) 72 mm / HALTERUNG (S) 72 mm

CODICE PART NUMBER EINZELNE RAMPE	L (mm) LUNGHEZZA LENGTH LÄNGE	PESO (Kg/coppia) WEIGHT (Kg/pair) GEWICHT (kg)/paar	P (mm) = passo / axle distance / Radstand Portata max alla coppia (Kg) Max machine weight calculated on a ramp pair (Kg) Max. Tragfähigkeit des Pairs (Kg)	C (mm) LARGH. INTERNA INTERNAL WIDTH INNERE BREITE	A (mm) LARGH. ESTERNA EXTERNAL WIDTH ÄUßERE BREITE	B (mm) ALTEZZA BORDO CURBS THICK. RANDHÖHE
---	--	---	---	---	---	---

VERSIONE CON BORDO / CURBS TYPE / VERSION MIT RAND - [TIPO / TYPE / TYP 10]

			750	1000	1250			
UELO715S10	1,500	18	1630	1630	1630	254	306	27
UELO720S10	2,000	23	1630	1630	1630	254	306	27
UELO725S10	2,500	28	1250	1400	1400	254	306	27
UELO730S10	3,000	33	970	1090	1250	254	306	27
UELO735S10	3,500	39	790	870	970	254	306	27
UELO715L10	1,500	24	1630	1630	1630	420	472	27
UELO720L10	2,000	30	1630	1630	1630	420	472	27
UELO725L10	2,500	36	1250	1400	1400	420	472	27
UELO730L10	3,000	43	970	1090	1250	420	472	27
UELO735L10	3,500	50	790	870	970	420	472	27

VERSIONE SENZA BORDO / NO CURBS TYPE / VERSION OHNE RAND - [TIPO / TYPE / TYP 00]

			750	1000	1250			
UELO715S00	1,500	18	1630	1630	1630	-	306	-
UELO720S00	2,000	23	1630	1630	1630	-	306	-
UELO725S00	2,500	28	1250	1400	1400	-	306	-
UELO730S00	3,000	33	970	1090	1250	-	306	-
UELO735S00	3,500	39	790	870	970	-	306	-
UELO715L00	1,500	24	1630	1630	1630	-	472	-
UELO720L00	2,000	30	1630	1630	1630	-	472	-
UELO725L00	2,500	36	1250	1400	1400	-	472	-
UELO730L00	3,000	43	970	1090	1250	-	472	-
UELO735L00	3,500	50	790	870	970	-	472	-

95mm

MONTANTE (S) / SUPPORT (S) / HALTERUNG (S)

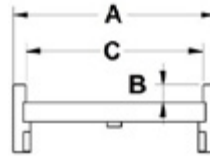
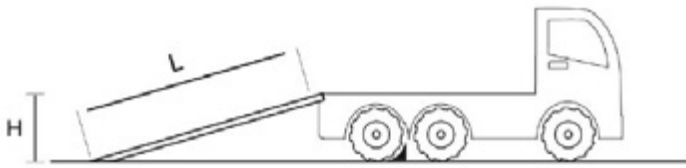

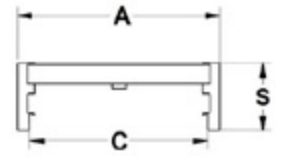

Tipo / Type / Typ
10 - 11



Tipo / Type / Typ
00 - 01

MONTANTE (S) 95 mm / SUPPORT (S) 95 mm / HALTERUNG (S) 95 mm

CODICE PART NUMBER EINZELNE RAMPE	L (mm) LUNGHEZZA LENGTH LÄNGE	PESO (Kg/coppia) WEIGHT (Kg/pair) GEWICHT (Kg/par)	P (mm) = passo / axle distance / Radstand 	C (mm) LARGH. INTERNA INTERNAL WIDTH INNERE BREITE	A (mm) LARGH. ESTERNA EXTERNAL WIDTH ÄUßERE BREITE	B (mm) ALTEZZA BORDO CURBS THICK. RANDHÖHE
			Portata max alla coppia (Kg) Max machine weight calculated on a ramp pair (Kg) Max. Tragfähigkeit des Pairs (Kg)			

VERSIONE CON BORDO / CURBS TYPE / VERSION MIT RAND - [TIPO / TYPE / TYP 10]

			1000	1250	1500			
UEL0925S10	2,500	41	2900	3000	3000	300	352	28
UEL0930S10	3,000	45	2170	2500	2900	300	352	28
UEL0932S10	3,200	47	1935	2230	2560	300	352	28
UEL0935S10	3,500	49	1700	1930	2170	300	352	28
UEL0940S10	4,000	53	1450	1580	1700	300	352	28

VERSIONE SENZA BORDO / NO CURBS TYPE / VERSION OHNE RAND - [TIPO / TYPE / TYP 00]

			1000	1250	1500			
UEL0925S00	2,500	41	2900	3000	3000	-	352	-
UEL0930S00	3,000	45	2170	2500	2900	-	352	-
UEL0932S00	3,200	47	1935	2230	2560	-	352	-
UEL0935S00	3,500	49	1700	1930	2170	-	352	-
UEL0940S00	4,000	53	1450	1580	1700	-	352	-

112mm

MONTANTE (S) / SUPPORT (S) / HALTERUNG (S)

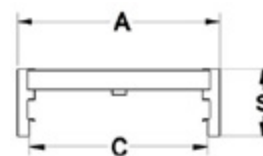
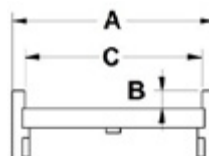
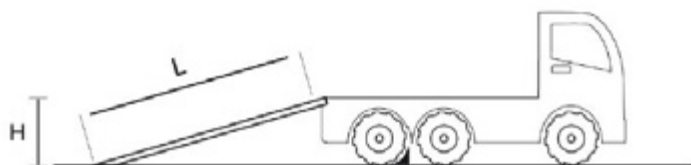

Tipo / Type / Typ
10 - 11

Tipo / Type / Typ
00 - 01

MONTANTE (S) 112 mm / SUPPORT (S) 112 mm / HALTERUNG (S) 112 mm								
CODICE PART NUMBER EINZELSTÜCKNUMMER	L (mm) LUNGHEZZA LENGTH LÄNGE	PESO (Kg/coppia) WEIGHT (Kg/pair) GEWICHT (Kg/paar)	P (mm) = passo / axle distance / Radstand			C (mm) LARGH. INTERNA INTERNAL WIDTH INNERE BREITE	A (mm) LARGH. ESTERNA EXTERNAL WIDTH ÄUßERE BREITE	B (mm) ALTEZZA BORDO CURBS THICK. RANDHÖHE
			<p>Portata max alla coppia (Kg) Max machine weight calculated on a ramp pair (Kg) Max. Tragfähigkeit des Paares (Kg)</p>					
VERSIONE CON BORDO / CURBS TYPE / VERSION MIT RAND - [TIPO / TYPE / TYP 10]								
			1000	1250	1500			
UEL1125S10	2,500	42	3730	4000	4000	300	352	45
UEL1130S10	3,000	47	2790	3190	3725	300	352	45
UEL1132S10	3,200	49	2540	2865	3285	300	352	45
UEL1135S10	3,500	51	2220	2470	2780	300	352	45
UEL1140S10	4,000	55	1830	2000	2200	300	352	45
UEL1130L10	3,000	51	2790	3190	3725	330	382	45
UEL1132L10	3,200	53	2540	2865	3285	330	382	45
UEL1135L10	3,500	55	2220	2470	2780	330	382	45
UEL1140L10	4,000	59	1830	2000	2200	330	382	45
VERSIONE SENZA BORDO / NO CURBS TYPE / VERSION OHNE RAND - [TIPO / TYPE / TYP 00]								
			1000	1250	1500			
UEL1125S00	2,500	42	3730	4000	4000	-	352	-
UEL1130S00	3,000	47	2790	3190	3725	-	352	-
UEL1132S00	3,200	49	2540	2865	3285	-	352	-
UEL1135S00	3,500	51	2220	2470	2780	-	352	-
UEL1140S00	4,000	55	1830	2000	2200	-	352	-
UEL1130L00	3,000	51	2790	3190	3725	-	382	-
UEL1132L00	3,200	53	2540	2865	3285	-	382	-
UEL1135L00	3,500	55	2220	2470	2780	-	382	-
UEL1140L00	4,000	59	1830	2000	2200	-	382	-

112mm

MONTANTE (S) / SUPPORT (S) / HALTERUNG (S)

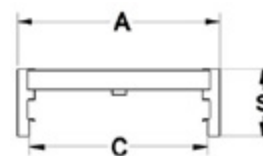
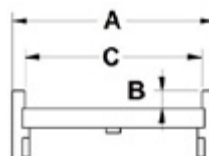
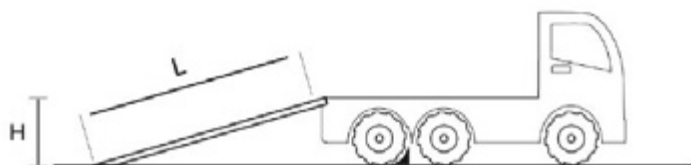

Tipo / Type / Typ
10 - 11

Tipo / Type / Typ
00 - 01

MONTANTE (S) 112 mm / SUPPORT (S) 112 mm / HALTERUNG (S) 112 mm								
CODICE PART NUMBER EINZELNE RAMPE	L (mm) LUNGHEZZA LENGTH LÄNGE	PESO (Kg/coppia) WEIGHT (Kg/pair) GEWICHT (Kg/paar)	P (mm) = passo / axle distance / Radstand			C (mm) LARGH. INTERNA INTERNAL WIDTH INNERE BREITE	A (mm) LARGH. ESTERNA EXTERNAL WIDTH ÄUSSERE BREITE	B (mm) ALTEZZA BORDO CURBS THICK. RANDHÖHE
			<p>Portata max alla coppia (Kg) Max machine weight calculated on a ramp pair (Kg) Max. Tragfähigkeit des Paares (Kg)</p>					
VERSIONE CON BORDO E RIVESTIMENTO IN GOMMA / CURBS TYPE WITH RUBBER BAND STRIPS / VERSION OHNE RAND, MIT GUMMIBELAG - [TIPO / TYPE / TYP 11]								
			1000	1250	1500			
UEL1125S11	2,500	67	3730	4000	4000	300	352	45
UEL1130S11	3,000	77	2790	3190	3725	300	352	45
UEL1132S11	3,200	81	2540	2865	3285	300	352	45
UEL1135S11	3,500	86	2220	2470	2780	300	352	45
UEL1140S11	4,000	95	1830	2000	2200	300	352	45
UEL1130L11	3,000	81	2790	3190	3725	330	382	45
UEL1132L11	3,200	85	2540	2865	3285	330	382	45
UEL1135L11	3,500	90	2220	2470	2780	330	382	45
UEL1140L11	4,000	99	1830	2000	2200	330	382	45
VERSIONE SENZA BORDO, CON RIVESTIMENTO IN GOMMA / NO CURBS TYPE, WITH RUBBER BAND STRIPS / VERSION OHNE RAND, MIT GUMMIBELAG - [TIPO / TYPE / TYP 01]								
			1000	1250	1500			
UEL1125S01	2,500	67	3730	4000	4000	-	352	-
UEL1130S01	3,000	77	2790	3190	3725	-	352	-
UEL1132S01	3,200	81	2540	2865	3285	-	352	-
UEL1135S01	3,500	86	2220	2470	2780	-	352	-
UEL1140S01	4,000	95	1830	2000	2200	-	352	-
UEL1130L01	3,000	81	2790	3190	3725	-	382	-
UEL1132L01	3,200	85	2540	2865	3285	-	382	-
UEL1135L01	3,500	90	2220	2470	2780	-	382	-
UEL1140L01	4,000	99	1830	2000	2200	-	382	-

127mm

MONTANTE (S) / SUPPORT (S) / HALTERUNG (S)

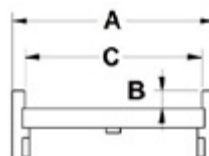
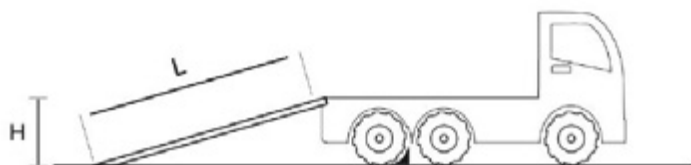

Tipo / Type / Typ
10 - 11

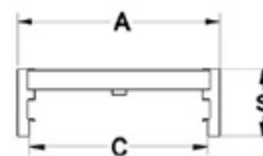

Tipo / Type / Typ
00 - 01

MONTANTE (S) 127 mm / SUPPORT (S) 127 mm / HALTERUNG (S) 127 mm								
CODICE PART NUMBER EINZELNE RAMPE	L (mm) LUNGHEZZA LENGTH LÄNGE	PESO (Kg/coppia) WEIGHT (Kg/pair) GEWICHT (Kg/paar)	P (mm) = passo / axle distance / Radstand  Portata max alla coppia (Kg) Max machine weight calculated on a ramp pair (Kg) Max. Tragfähigkeit des Paares (Kg)			C (mm) LARGH. INTERNA INTERNAL WIDTH INNERE BREITE	A (mm) LARGH. ESTERNA EXTERNAL WIDTH ÄUßERE BREITE	B (mm) ALTEZZA BORDO CURBS THICK. RANDHÖHE
VERSIONE CON BORDO / CURBS TYPE / VERSION MIT RAND - [TIPO / TYPE / TYP 10]								
			1000	1250	1500			
UEL1230S10	3,000	52	3815	3970	3970	320	372	45
UEL1232S10	3,200	55	3470	3910	3970	320	372	45
UEL1235S10	3,500	57	3050	3390	3815	320	372	45
UEL1240S10	4,000	62	2540	2770	3050	320	372	45
UEL1230L10	3,000	55	3315	3470	3470	350	402	45
UEL1232L10	3,200	58	2970	3410	3470	350	402	45
UEL1235L10	3,500	60	2550	2890	3315	350	402	45
UEL1240L10	4,000	65	2040	2270	2550	350	402	45
VERSIONE SENZA BORDO / NO CURBS TYPE / VERSION OHNE RAND - [TIPO / TYPE / TYP 00]								
			1000	1250	1500			
UEL1230S00	3,000	52	3815	3970	3970	-	372	-
UEL1232S00	3,200	55	3470	3910	3970	-	372	-
UEL1235S00	3,500	57	3050	3390	3815	-	372	-
UEL1240S00	4,000	62	2540	2770	3050	-	372	-
UEL1230L00	3,000	55	3315	3470	3470	-	402	-
UEL1232L00	3,200	58	2970	3410	3470	-	402	-
UEL1235L00	3,500	60	2550	2890	3315	-	402	-
UEL1240L00	4,000	65	2040	2270	2550	-	402	-

127mm

MONTANTE (S) / SUPPORT (S) / HALTERUNG (S)

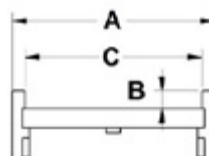
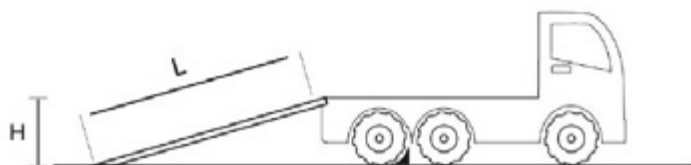

Tipo / Type / Typ
10 - 11

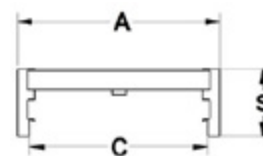

Tipo / Type / Typ
00 - 01

MONTANTE (S) 127 mm / SUPPORT (S) 127 mm / HALTERUNG (S) 127 mm								
CODICE PART NUMBER EINZELNE RAMPE	L (mm) LUNGHEZZA LENGTH LÄNGE	PESO (Kg/coppia) WEIGHT (Kg/pair) GEWICHT (Kg/paar)	P (mm) = passo / axle distance / Radstand  Portata max alla coppia (Kg) Max machine weight calculated on a ramp pair (Kg) Max. Tragfähigkeit des Paares (Kg)			C (mm) LARGH. INTERNA INTERNAL WIDTH INNERE BREITE	A (mm) LARGH. ESTERNA EXTERNAL WIDTH ÄUßERE BREITE	B (mm) ALTEZZA BORDO CURBS THICK. RANDHÖHE
VERSIONE CON BORDO E RIVESTIMENTO IN GOMMA / CURBS TYPE WITH RUBBER BAND STRIPS / VERSION OHNE RAND, MIT GUMMIBELAG - [TIPO / TYPE / TYP 11]								
			1000	1250	1500			
UEL1230S11	3,000	82	3820	3970	3970	320	372	45
UEL1232S11	3,200	87	3470	3915	3970	320	372	45
UEL1235S11	3,500	92	3050	3390	3815	320	372	45
UEL1240S11	4,000	102	2540	2770	3050	320	372	45
UEL1230L11	3,000	85	3320	3470	3470	350	402	45
UEL1232L11	3,200	90	2970	3415	3470	350	402	45
UEL1235L11	3,500	95	2550	2890	3315	350	402	45
UEL1240L11	4,000	105	2040	2270	2550	350	402	45
VERSIONE SENZA BORDO, CON RIVESTIMENTO IN GOMMA / NO CURBS TYPE, WITH RUBBER BAND STRIPS / VERSION OHNE RAND, MIT GUMMIBELAG - [TIPO / TYPE / TYP 01]								
			1000	1250	1500			
UEL1230S01	3,000	82	3820	3970	3970	-	372	-
UEL1232S01	3,200	87	3470	3915	3970	-	372	-
UEL1235S01	3,500	92	3050	3390	3815	-	372	-
UEL1240S01	4,000	102	2540	2770	3050	-	372	-
UEL1230L01	3,000	85	3320	3470	3470	-	402	-
UEL1232L01	3,200	90	2970	3415	3470	-	402	-
UEL1235L01	3,500	95	2550	2890	3315	-	402	-
UEL1240L01	4,000	105	2040	2270	2550	-	402	-

140mm

MONTANTE (S) / SUPPORT (S) / HALTERUNG (S)

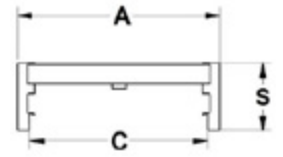
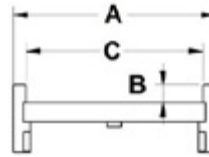
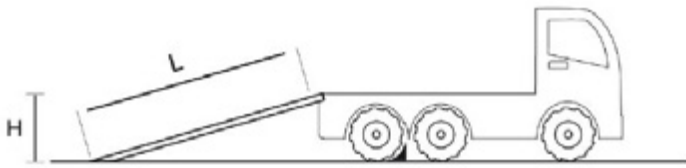

Tipo / Type / Typ
10 - 11

Tipo / Type / Typ
00 - 01

MONTANTE (S) 140 mm / SUPPORT (S) 140 mm / HALTERUNG (S) 140 mm

CODICE PART NUMBER EINZELNE RAMPE	L (mm) LUNGHEZZA LENGTH LÄNGE	PESO (Kg/coppia) WEIGHT (Kg/pair) GEWICHT (Kg/paar)	P (mm) = passo / axle distance / Radstand  Portata max alla coppia (Kg) Max machine weight calculated on a ramp pair (Kg) Max. Tragfähigkeit des Paares (Kg)	C (mm) LARGH. INTERNA INTERNAL WIDTH INNERE BREITE	A (mm) LARGH. ESTERNA EXTERNAL WIDTH ÄUSSERE BREITE	B (mm) ALTEZZA BORDO CURBS THICK. RANDHÖHE
---	--	---	--	---	--	---

VERSIONE CON BORDO / CURBS TYPE / VERSION MIT RAND - [TIPO / TYPE / TYP 10]

			1500	1750	2000			
UEL1430S10	3,000	77	6570	6755	7390	370	422	38
UEL1435S10	3,500	92	4920	5625	5740	370	422	38
UEL1440S10	4,000	101	3935	4520	5085	370	422	38
UEL1445S10	4,500	117	3275	3570	3930	370	422	38
UEL1435L10	3,500	98	4920	5625	5740	420	472	38
UEL1440L10	4,000	107	3935	4520	5085	420	472	38
UEL1445L10	4,500	124	3275	3570	3930	420	472	38

VERSIONE SENZA BORDO / NO CURBS TYPE / VERSION OHNE RAND - [TIPO / TYPE / TYP 00]

			1500	1750	2000			
UEL1430S00	3,000	77	6570	6755	7390	-	422	-
UEL1435S00	3,500	92	4920	5625	5740	-	422	-
UEL1440S00	4,000	101	3935	4520	5085	-	422	-
UEL1445S00	4,500	117	3275	3570	3930	-	422	-
UEL1435L00	3,500	98	4920	5625	5740	-	472	-
UEL1440L00	4,000	107	3935	4520	5085	-	472	-
UEL1445L00	4,500	124	3275	3570	3930	-	472	-

140mm

MONTANTE (S) / SUPPORT (S) / HALTERUNG (S)

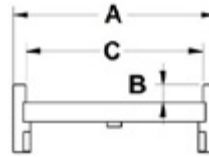
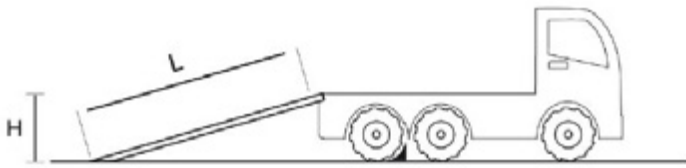

Tipo / Type / Typ
10 - 11

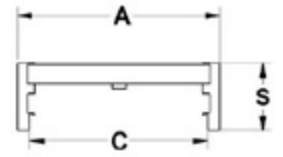

Tipo / Type / Typ
00 - 01

MONTANTE (S) 140 mm / SUPPORT (S) 140 mm / HALTERUNG (S) 140 mm								
CODICE PART NUMBER EINZELNE RAMPE	L (mm) LUNGHEZZA LENGTH LÄNGE	PESO (Kg/coppia) WEIGHT (Kg/pair) GEWICHT (Kg/paar)	P (mm) = passo / axle distance / Radstand  Portata max alla coppia (Kg) Max machine weight calculated on a ramp pair (Kg) Max. Tragfähigkeit des Paares (Kg)			C (mm) LARGH. INTERNA INTERNAL WIDTH INNERE BREITE	A (mm) LARGH. ESTERNA EXTERNAL WIDTH ÄUßERE BREITE	B (mm) ALTEZZA BORDO CURBS THICK. RANDHÖHE
VERSIONE CON BORDO E RIVESTIMENTO IN GOMMA / CURBS TYPE WITH RUBBER BAND STRIPS / VERSION OHNE RAND, MIT GUMMIBELAG - [TIPO / TYPE / TYP 11]								
			1500	1750	2000			
UEL1430S11	3,000	107	6570	6755	7390	370	422	38
UEL1435S11	3,500	130	4920	5625	5740	370	422	38
UEL1440S11	4,000	141	3935	4520	5085	370	422	38
UEL1445S11	4,500	162	3275	3575	3930	370	422	38
UEL1435L11	3,500	133	4920	5625	5740	420	472	38
UEL1440L11	4,000	147	3935	4520	5085	420	472	38
UEL1445L11	4,500	169	3275	3570	3930	420	472	38
VERSIONE SENZA BORDO, CON RIVESTIMENTO IN GOMMA / NO CURBS TYPE, WITH RUBBER BAND STRIPS / VERSION OHNE RAND, MIT GUMMIBELAG - [TIPO / TYPE / TYP 01]								
			1500	1750	2000			
UEL1430S01	3,000	107	6570	6755	7390	-	422	-
UEL1435S01	3,500	130	4920	5625	5740	-	422	-
UEL1440S01	4,000	141	3935	4520	5085	-	422	-
UEL1445S01	4,500	162	3275	3575	3930	-	422	-
UEL1435L01	3,500	133	4920	5625	5740	-	472	-
UEL1440L01	4,000	147	3935	4520	5085	-	472	-
UEL1445L01	4,500	169	3275	3570	3930	-	472	-

155mm

MONTANTE (S) / SUPPORT (S) / HALTERUNG (S)

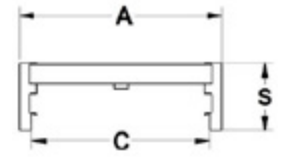
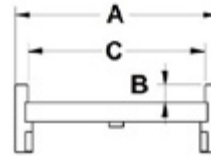
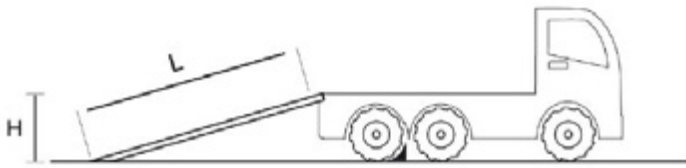

Tipo / Type / Typ
10 - 11

Tipo / Type / Typ
00 - 01

MONTANTE (S) 155 mm / SUPPORT (S) 155 mm / HALTERUNG (S) 155 mm

CODICE PART NUMBER EINZELNE RAMPE	L (mm) LUNGHEZZA LENGTH LÄNGE	PESO (Kg/coppia) WEIGHT (Kg/pair) GEWICHT (Kg/paar)	P (mm) = passo / axle distance / Radstand Portata max alla coppia (Kg) Max machine weight calculated on a ramp pair (Kg) Max. Tragfähigkeit des Paares (Kg)	C (mm) LARGH. INTERNA INTERNAL WIDTH INNERE BREITE	A (mm) LARGH. ESTERNA EXTERNAL WIDTH ÄUßERE BREITE	B (mm) ALTEZZA BORDO CURBS THICK. RANDHÖHE
---	--	---	--	---	---	---

VERSIONE CON BORDO / CURBS TYPE / VERSION MIT RAND - [TIPO / TYPE / TYP 10]

			1500	1750	2000			
UEL1530S10	3,000	87	8620	8865	9695	400	452	45
UEL1535S10	3,500	105	6460	7380	7535	400	452	45
UEL1540S10	4,000	115	5165	5740	6455	400	452	45
UEL1545S10	4,500	136	4300	4690	5160	400	452	45
UEL1550S10	5,000	142	3680	3965	4295	400	452	45
UEL1530L10	3,000	92	8620	8865	9695	450	502	45
UEL1535L10	3,500	110	6460	7380	7535	450	502	45
UEL1540L10	4,000	121	5165	5740	6455	450	502	45
UEL1545L10	4,500	139	4300	4690	5160	450	502	45
UEL1550L10	5,000	150	3680	3965	4295	450	502	45

VERSIONE SENZA BORDO / NO CURBS TYPE / VERSION OHNE RAND - [TIPO / TYPE / TYP 00]

			1500	1750	2000			
UEL1530S00	3,000	87	8620	8865	9695	-	452	-
UEL1535S00	3,500	105	6460	7380	7535	-	452	-
UEL1540S00	4,000	115	5165	5740	6455	-	452	-
UEL1545S00	4,500	136	4300	4690	5160	-	452	-
UEL1550S00	5,000	142	3680	3965	4295	-	452	-
UEL1530L00	3,000	92	8620	8865	9695	-	502	-
UEL1535L00	3,500	110	6460	7380	7535	-	502	-
UEL1540L00	4,000	121	5165	5740	6455	-	502	-
UEL1545L00	4,500	139	4300	4690	5160	-	502	-
UEL1550L00	5,000	150	3680	3965	4295	-	502	-

155mm

MONTANTE (S) / SUPPORT (S) / HALTERUNG (S)

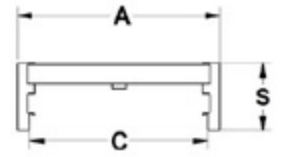
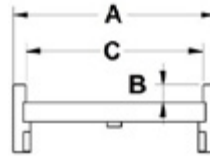
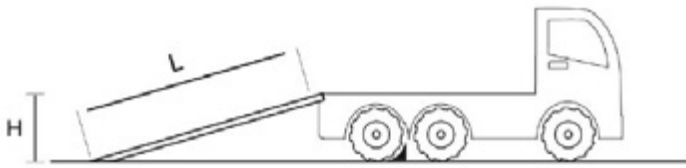

Tipo / Type / Typ
10 - 11

Tipo / Type / Typ
00 - 01

MONTANTE (S) 155 mm / SUPPORT (S) 155 mm / HALTERUNG (S) 155 mm

CODICE PART NUMBER EINZELNE RAMPE	L (mm) LUNGHEZZA LENGTH LÄNGE	PESO (Kg/coppia) WEIGHT (Kg/pair) GEWICHT (Kg/paar)	P (mm) = passo / axle distance / Radstand  Portata max alla coppia (Kg) Max machine weight calculated on a ramp pair (Kg) Max. Tragfähigkeit des Paares (Kg)	C (mm) LARGH. INTERNA INTERNAL WIDTH INNERE BREITE	A (mm) LARGH. ESTERNA EXTERNAL WIDTH ÄUßERE BREITE	B (mm) ALTEZZA BORDO CURBS THICK. RANDHÖHE
---	--	---	--	---	---	---

VERSIONE CON BORDO E RIVESTIMENTO IN GOMMA / CURBS TYPE WITH RUBBER BAND STRIPS / VERSION OHNE RAND, MIT GUMMIBELAG - [TIPO / TYPE / TYP 11]

			1500	1750	2000			
UEL1530S11	3,000	117	8620	8865	9695	400	452	45
UEL1535S11	3,500	140	6460	7380	7535	400	452	45
UEL1540S11	4,000	155	5165	5740	6455	400	452	45
UEL1545S11	4,500	181	4300	4690	5160	400	452	45
UEL1550S11	5,000	192	3680	3965	4295	400	452	45
UEL1530L11	3,000	122	8620	8865	9695	450	502	45
UEL1535L11	3,500	145	6460	7380	7535	450	502	45
UEL1540L11	4,000	161	5165	5740	6455	450	502	45
UEL1545L11	4,500	184	4300	4690	5160	450	502	45
UEL1550L11	5,000	200	3680	3965	4295	450	502	45

VERSIONE SENZA BORDO, CON RIVESTIMENTO IN GOMMA / NO CURBS TYPE, WITH RUBBER BAND STRIPS / VERSION OHNE RAND, MIT GUMMIBELAG - [TIPO / TYPE / TYP 01]

			1500	1750	2000			
UEL1530S01	3,000	117	8620	8865	9695	-	452	-
UEL1535S01	3,500	140	6460	7380	7535	-	452	-
UEL1540S01	4,000	155	5165	5740	6455	-	452	-
UEL1545S01	4,500	181	4300	4690	5160	-	452	-
UEL1550S01	5,000	192	3680	3965	4295	-	452	-
UEL1530L01	3,000	122	8620	8865	9695	-	502	-
UEL1535L01	3,500	145	6460	7380	7535	-	502	-
UEL1540L01	4,000	161	5165	5740	6455	-	502	-
UEL1545L01	4,500	184	4300	4690	5160	-	502	-
UEL1550L01	5,000	200	3680	3965	4295	-	502	-

170mm

MONTANTE (S) / SUPPORT (S) / HALTERUNG (S)

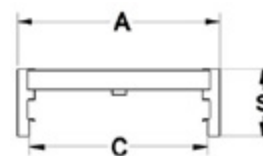
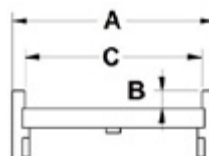
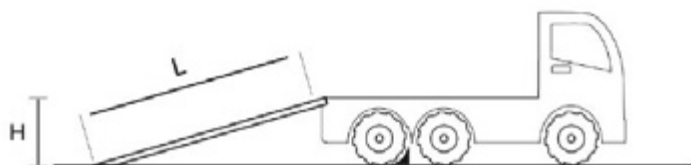

Tipo / Type / Typ
10 - 11

Tipo / Type / Typ
00 - 01

MONTANTE (S) 170 mm / SUPPORT (S) 170 mm / HALTERUNG (S) 170 mm								
CODICE PART NUMBER EINZELNE RAMPE	L (mm) LUNGHEZZA LENGTH LÄNGE	PESO (Kg/coppia) WEIGHT (Kg/pair) GEWICHT (Kg/paar)	P (mm) = passo / axle distance / Radstand Portata max alla coppia (Kg) Max machine weight calculated on a ramp pair (Kg) Max. Tragfähigkeit des Pairs (Kg)			C (mm) LARGH. INTERNA INTERNAL WIDTH INNERE BREITE	A (mm) LARGH. ESTERNA EXTERNAL WIDTH ÄUßERE BREITE	B (mm) ALTEZZA BORDO CURBS THICK. RANDHÖHE
VERSIONE CON BORDO / CURBS TYPE / VERSION MIT RAND - [TIPO / TYPE / TYP 10]								
			1500	1750	2000			
UEL1730S10	3,000	93	9200	9500	9800	420	492	28
UEL1735S10	3,500	105	7500	8200	8500	420	492	28
UEL1740S10	4,000	117	6050	6720	7560	420	492	28
UEL1745S10	4,500	129	5000	5450	6045	420	492	28
UEL1750S10	5,000	141	4250	4600	5030	420	492	28
UEL1730L10	3,000	101	9200	9500	9800	500	572	28
UEL1735L10	3,500	115	7500	8200	8500	500	572	28
UEL1740L10	4,000	129	6050	6720	7560	500	572	28
UEL1745L10	4,500	143	5000	5450	6045	500	572	28
UEL1750L10	5,000	155	4250	4600	5030	500	572	28
VERSIONE SENZA BORDO / NO CURBS TYPE / VERSION OHNE RAND - [TIPO / TYPE / TYP 00]								
			1500	1750	2000			
UEL1730S00	3,000	93	9200	9500	9800	-	492	-
UEL1735S00	3,500	105	7500	8200	8500	-	492	-
UEL1740S00	4,000	117	6050	6720	7560	-	492	-
UEL1745S00	4,500	129	5000	5450	6045	-	492	-
UEL1750S00	5,000	141	4250	4600	5030	-	492	-
UEL1730L00	3,000	101	9200	9500	9800	-	572	-
UEL1735L00	3,500	115	7500	8200	8500	-	572	-
UEL1740L00	4,000	129	6050	6720	7560	-	572	-
UEL1745L00	4,500	143	5000	5450	6045	-	572	-
UEL1750L00	5,000	155	4250	4600	5030	-	572	-

170mm

MONTANTE (S) / SUPPORT (S) / HALTERUNG (S)

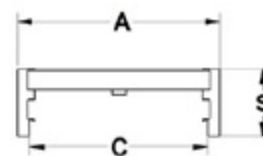
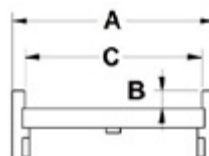
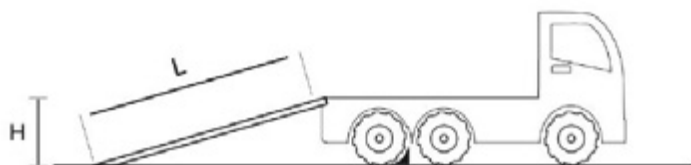

Tipo / Type / Typ
10 - 11

Tipo / Type / Typ
00 - 01

MONTANTE (S) 170 mm / SUPPORT (S) 170 mm / HALTERUNG (S) 170 mm

CODICE PART NUMBER EINZELNE RAMPE	L (mm) LUNGHEZZA LENGTH LÄNGE	PESO (Kg/coppia) WEIGHT (Kg/pair) GEWICHT (Kg/paar)	P (mm) = passo / axle distance / Radstand			C (mm) LARGH. INTERNA INTERNAL WIDTH INNERE BREITE	A (mm) LARGH. ESTERNA EXTERNAL WIDTH ÄUßERE BREITE	B (mm) ALTEZZA BORDO CURBS THICK. RANDHÖHE
			 Portata max alla coppia (Kg) Max machine weight calculated on a ramp pair (Kg) Max. Tragfähigkeit des Paares (Kg)					
VERSIONE CON BORDO E RIVESTIMENTO IN GOMMA / CURBS TYPE WITH RUBBER BAND STRIPS / VERSION OHNE RAND, MIT GUMMIBELAG - [TIPO / TYPE / TYP 11]								
			1500	1750	2000			
UEL1730S11	3,000	87	9200	9500	9800	420	492	28
UEL1735S11	3,500	105	7500	8200	8500	420	492	28
UEL1740S11	4,000	115	6050	6720	7560	420	492	28
UEL1745S11	4,500	136	5000	5450	6045	420	492	28
UEL1750S11	5,000	142	4250	4600	5030	420	492	28
UEL1730L11	3,000	92	9200	9500	9800	500	572	28
UEL1735L11	3,500	110	7500	8200	8500	500	572	28
UEL1740L11	4,000	121	6050	6720	7560	500	572	28
UEL1745L11	4,500	139	5000	5450	6045	500	572	28
UEL1750L11	5,000	150	4250	4600	5030	500	572	28
VERSIONE SENZA BORDO, CON RIVESTIMENTO IN GOMMA / NO CURBS TYPE, WITH RUBBER BAND STRIPS / VERSION OHNE RAND, MIT GUMMIBELAG - [TIPO / TYPE / TYP 01]								
			1500	1750	2000			
UEL1730S01	3,000	87	9200	9500	9800	—	492	—
UEL1735S01	3,500	105	7500	8200	8500	—	492	—
UEL1740S01	4,000	115	6050	6720	7560	—	492	—
UEL1745S01	4,500	136	5000	5450	6045	—	492	—
UEL1750S01	5,000	142	4250	4600	5030	—	492	—
UEL1730L01	3,000	92	9200	9500	9800	—	572	—
UEL1735L01	3,500	110	7500	8200	8500	—	572	—
UEL1740L01	4,000	121	6050	6720	7560	—	572	—
UEL1745L01	4,500	139	5000	5450	6045	—	572	—
UEL1750L01	5,000	150	4250	4600	5030	—	572	—

190mm

MONTANTE (S) / SUPPORT (S) / HALTERUNG (S)

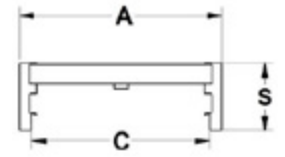
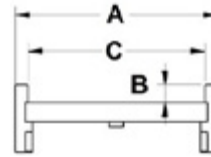
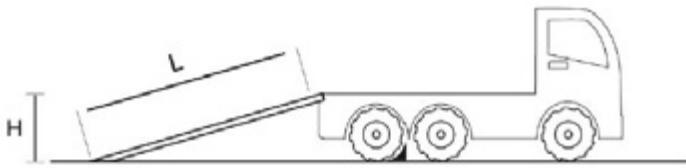

Tipo / Type / Typ
10 - 11

Tipo / Type / Typ
00 - 01

MONTANTE (S) 190 mm / SUPPORT (S) 190 mm / HALTERUNG (S) 190 mm								
CODICE PART NUMBER EINZELNE RAMPE	L (mm) LUNGHEZZA LENGTH LÄNGE	PESO (Kg/coppia) WEIGHT (Kg/pair) GEWICHT (Kg/paar)	P (mm) = passo / axle distance / Radstand Portata max alla coppia (Kg) Max machine weight calculated on a ramp pair (Kg) Max. Tragfähigkeit des Paares (Kg)			C (mm) LARGH. INTERNA INTERNAL WIDTH INNERE BREITE	A (mm) LARGH. ESTERNA EXTERNAL WIDTH ÄUßERE BREITE	B (mm) ALTEZZA BORDO CURBS THICK. RANDHÖHE
VERSIONE CON BORDO / CURBS TYPE / VERSION MIT RAND - [TIPO / TYPE / TYP 10]								
			1500	1750	2000			
UEL1935S10	3,500	132	9920	10170	10170	500	552	60
UEL1940S10	4,000	145	7930	8815	9920	500	552	60
UEL1945S10	4,500	167	6605	7210	7930	500	552	60
UEL1950S10	5,000	180	5660	6095	6600	500	552	60
VERSIONE SENZA BORDO / NO CURBS TYPE / VERSION OHNE RAND - [TIPO / TYPE / TYP 00]								
			1500	1750	2000			
UEL1935S00	3,500	132	9920	10170	10170	-	552	-
UEL1940S00	4,000	145	7930	8815	9920	-	552	-
UEL1945S00	4,500	167	6605	7210	7930	-	552	-
UEL1950S00	5,000	180	5660	6095	6600	-	552	-
VERSIONE CON BORDO / CURBS TYPE / VERSION MIT RAND - [TIPO / TYPE / TYP 10]								
			1500	1750	2000			
UEL1935S11	3,500	167	9920	10170	10170	500	552	60
UEL1940S11	4,000	185	7930	8815	9920	500	552	60
UEL1945S11	4,500	212	6605	7210	7930	500	552	60
UEL1950S11	5,000	240	5660	6095	6600	500	552	60
VERSIONE SENZA BORDO, CON RIVESTIMENTO IN GOMMA / NO CURBS TYPE, WITH RUBBER BAND STRIPS / VERSION OHNE RAND, MIT GUMMIBELAG - [TIPO / TYPE / TYP 01]								
			1500	1750	2000			
UEL1935S01	3,500	167	9920	10170	10170	-	552	-
UEL1940S01	4,000	185	7930	8815	9920	-	552	-
UEL1945S01	4,500	212	6605	7210	7930	-	552	-
UEL1950S01	5,000	240	5660	6095	6600	-	552	-

220mm

MONTANTE (S) / SUPPORT (S) / HALTERUNG (S)

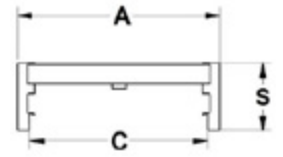
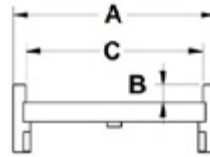
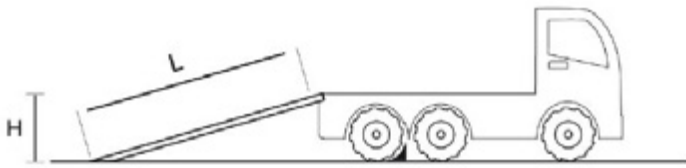

Tipo / Type / Typ
10 - 11

Tipo / Type / Typ
00 - 01

MONTANTE (S) 220 mm / SUPPORT (S) 220 mm / HALTERUNG (S) 220 mm

CODICE PART NUMBER EINZELNE RAMPE	L (mm) LUNGHEZZA LENGTH LÄNGE	PESO (Kg/coppia) WEIGHT (Kg/pair) GEWICHT (Kg/paar)	P (mm) = passo / axle distance / Radstand Portata max alla coppia (Kg) Max machine weight calculated on a ramp pair (Kg) Max. Tragfähigkeit des Paares (Kg)	C (mm) LARGH. INTERNA INTERNAL WIDTH INNERE BREITE	A (mm) LARGH. ESTERNA EXTERNAL WIDTH ÄUßERE BREITE	B (mm) ALTEZZA BORDO CURBS THICK. RANDHÖHE
---	--	---	--	---	---	---

VERSIONE CON BORDO / CURBS TYPE / VERSION MIT RAND - [TIPO / TYPE / TYP 10]

			1500	1750	2000			
UEL2235S10	3,500	160	12600	12600	12600	500	576	60
UEL2240S10	4,000	175	12270	12600	12600	500	576	60
UEL2245S10	4,500	206	10215	11145	12260	500	576	60
UEL2250S10	5,000	220	8750	9425	10210	500	576	60
UEL2235L10	3,500	167	12600	12600	12600	584	660	60
UEL2240L10	4,000	182	12270	12600	12600	584	660	60
UEL2245L10	4,500	212	10215	11145	12260	584	660	60
UEL2250L10	5,000	227	8750	9425	10210	584	660	60

VERSIONE SENZA BORDO / NO CURBS TYPE / VERSION OHNE RAND - [TIPO / TYPE / TYP 00]

			1500	1750	2000			
UEL2235S00	3,500	160	12600	12600	12600	-	576	-
UEL2240S00	4,000	175	12270	12600	12600	-	576	-
UEL2245S00	4,500	206	10215	11145	12260	-	576	-
UEL2250S00	5,000	220	8750	9425	10210	-	576	-
UEL2235L00	3,500	167	12600	12600	12600	-	660	-
UEL2240L00	4,000	182	12270	12600	12600	-	660	-
UEL2245L00	4,500	212	10215	11145	12260	-	660	-
UEL2250L00	5,000	227	8750	9425	10210	-	660	-

220mm

MONTANTE (S) / SUPPORT (S) / HALTERUNG (S)

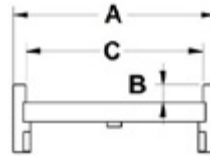
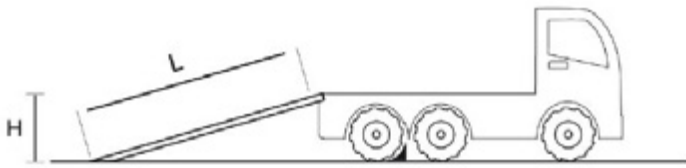

Tipo / Type / Typ
10 - 11

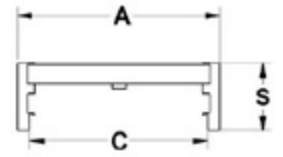

Tipo / Type / Typ
00 - 01

MONTANTE (S) 220 mm / SUPPORT (S) 220 mm / HALTERUNG (S) 220 mm

CODICE PART NUMBER EINZELNE RAMPE	L (mm) LUNGHEZZA LENGTH LÄNGE	PESO (Kg/coppia) WEIGHT (Kg/pair) GEWICHT (Kg/paar)	P (mm) = passo / axle distance / Radstand			C (mm) LARGH. INTERNA INTERNAL WIDTH INNERE BREITE	A (mm) LARGH. ESTERNA EXTERNAL WIDTH ÄUßERE BREITE	B (mm) ALTEZZA BORDO CURBS THICK. RANDHÖHE
			 <p>Portata max alla coppia (Kg) Max machine weight calculated on a ramp pair (Kg) Max. Tragfähigkeit des Paares (Kg)</p>					
VERSIONE CON BORDO E RIVESTIMENTO IN GOMMA / CURBS TYPE WITH RUBBER BAND STRIPS / VERSION OHNE RAND, MIT GUMMIBELAG - [TIPO / TYPE / TYP 11]								
			1500	1750	2000			
UEL2235S11	3,500	160	12600	12600	12600	500	576	60
UEL2240S11	4,000	175	12270	12600	12600	500	576	60
UEL2245S11	4,500	206	10215	11145	12260	500	576	60
UEL2250S11	5,000	220	8750	9425	10210	500	576	60
UEL2235L11	3,500	167	12600	12600	12600	584	660	60
UEL2240L11	4,000	182	12270	12600	12600	584	660	60
UEL2245L11	4,500	212	10215	11145	12260	584	660	60
UEL2250L11	5,000	227	8750	9425	10210	584	660	60
VERSIONE SENZA BORDO, CON RIVESTIMENTO IN GOMMA / NO CURBS TYPE, WITH RUBBER BAND STRIPS / VERSION OHNE RAND, MIT GUMMIBELAG - [TIPO / TYPE / TYP 01]								
			1500	1750	2000			
UEL2235S01	3,500	160	12600	12600	12600	-	576	-
UEL2240S01	4,000	175	12270	12600	12600	-	576	-
UEL2245S01	4,500	206	10215	11145	12260	-	576	-
UEL2250S01	5,000	220	8750	9425	10210	-	576	-
UEL2235L01	3,500	167	12600	12600	12600	-	660	-
UEL2240L01	4,000	182	12270	12600	12600	-	660	-
UEL2245L01	4,500	212	10215	11145	12260	-	660	-
UEL2250L01	5,000	227	8750	9425	10210	-	660	-

DIAGRAMMA

CHART
DIAGRAMM

Altezza pianale (mm)
Load bed height (mm)
Plattformhöhe (mm)

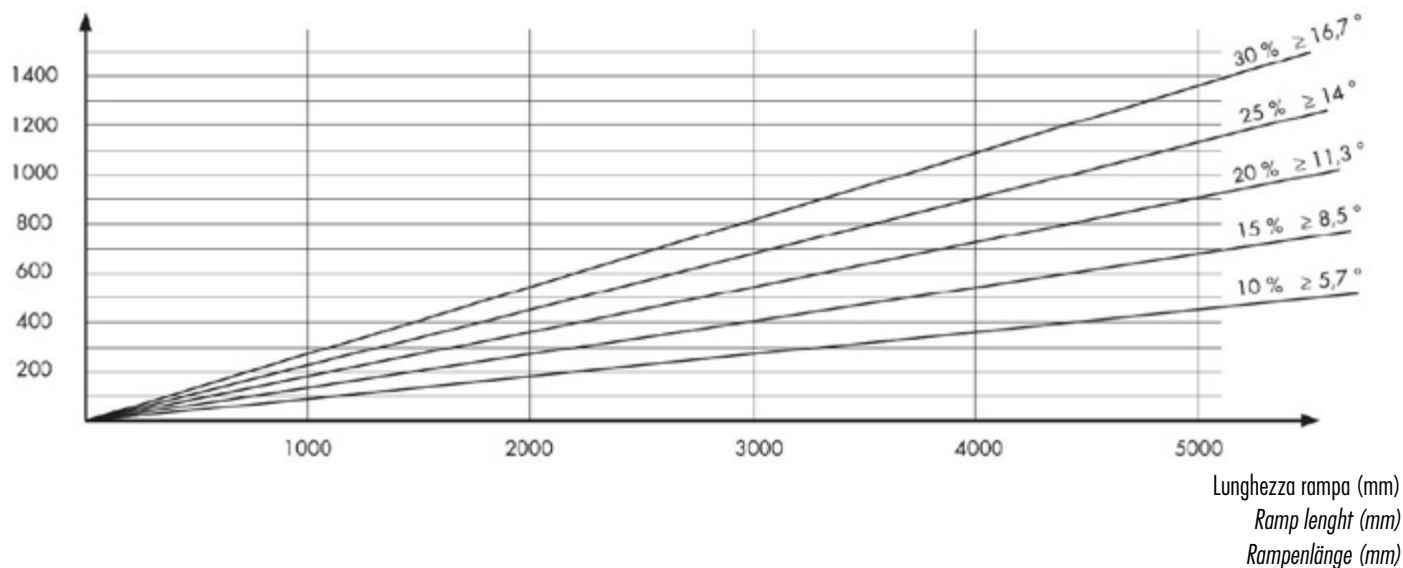

Nel diagramma si può facilmente determinare la lunghezza della rampa in relazione dell'altezza del pianale di carico (in mm) e dell'inclinazione a cui verrà utilizzata la rampa (in gradienti). Ad esempio: Con una differenza di altezza di 1200 mm e gradiente massimo del 30%, quanto deve essere lunga la rampa?

Through the diagram you can easily determine the length of the loading ramp in relation of the truck floor height (mm.) and the inclination (in gradient) that you want use. Example: With a truck floor height of 1200 mm and a gradient of 30 %, which is the ramp length?

Diagramm können die Rampenlänge in Bezug auf die Höhe der Ladeplattform (in mm) sowie die Neigung (in Graden), mit der die Rampe verwendet wird, leicht ermittelt werden. Zum Beispiel: Wie lang sollte die Rampe bei einem Höhenunterschied von 1200 mm und einer maximalen Neigung von 30 % sein?

$$\frac{1200 \text{ mm} \times 100}{30} = 4000$$

È SCONSIGLIATO L'USO DI UNA RAMPA CON GRADIENTE MAGGIORE AL 30%
IT IS NOT RECOMMENDED TO USE RAMPS WITH A GRADIENT HIGHER THAN 30%.
VON EINER VERWENDUNG VON RAMPEN MIT EINER NEIGUNG VON MEHR ALS 30 % WIRD ABGERATEN.



PASSION FOR PARTS